

# AMP (full width container)

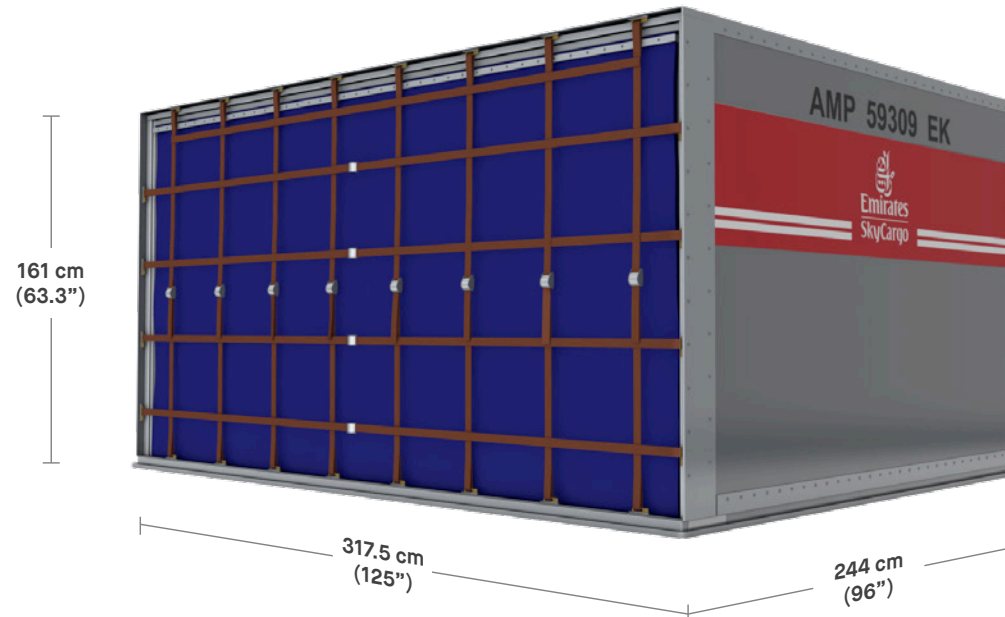

Full-length lower deck container.

Special instructions: do not use forklift to lift the unit or store on ground without any base support (restricted to permitted weight per bay/position on aircraft against max. gross weight).

## CHARACTERISTICS

<b>Standard tare weight</b>	.....	271kg
<b>Max. gross weight</b>	.....	6,804kg
<b>Volume</b>	.....	10.8m <sup>3</sup>

# Horse stall

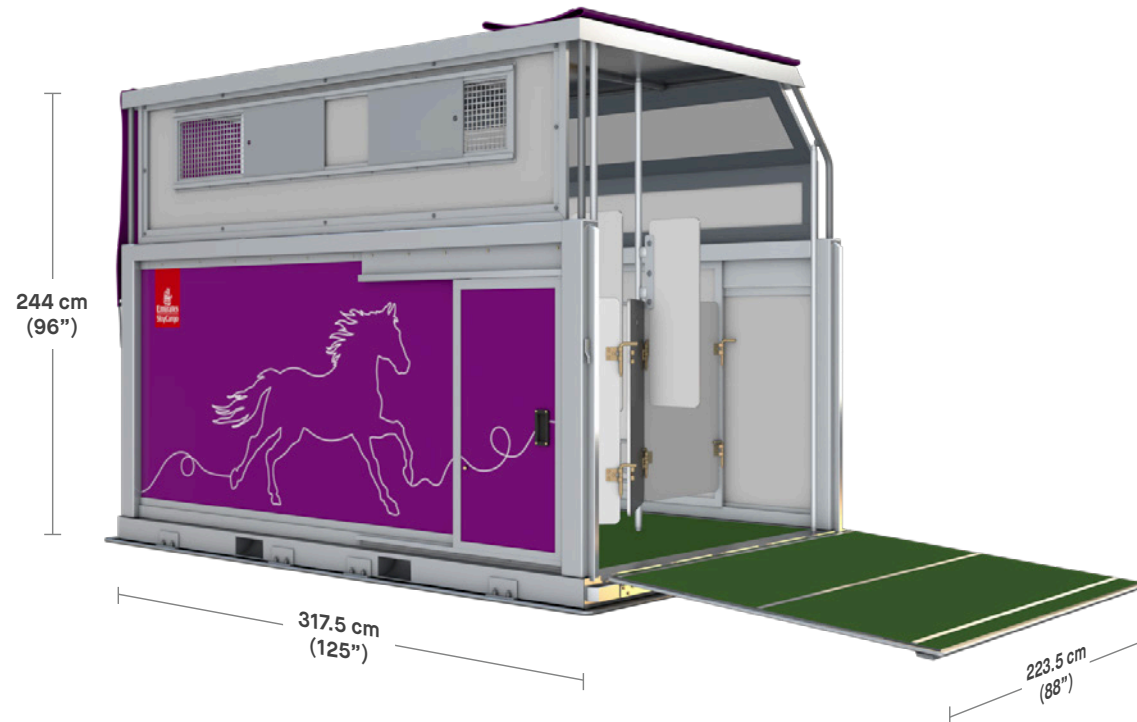

PM base with IATA-specified horse box stalls.  
Available with canvas top or solid roof.

## CHARACTERISTICS

Volume .....	15.3m <sup>3</sup>
Standard tare weight .....	1,310kg
Max. gross weight .....	3,500kg
Door .....	3 horses

# LD3 (AKE contoured container with canvas door)

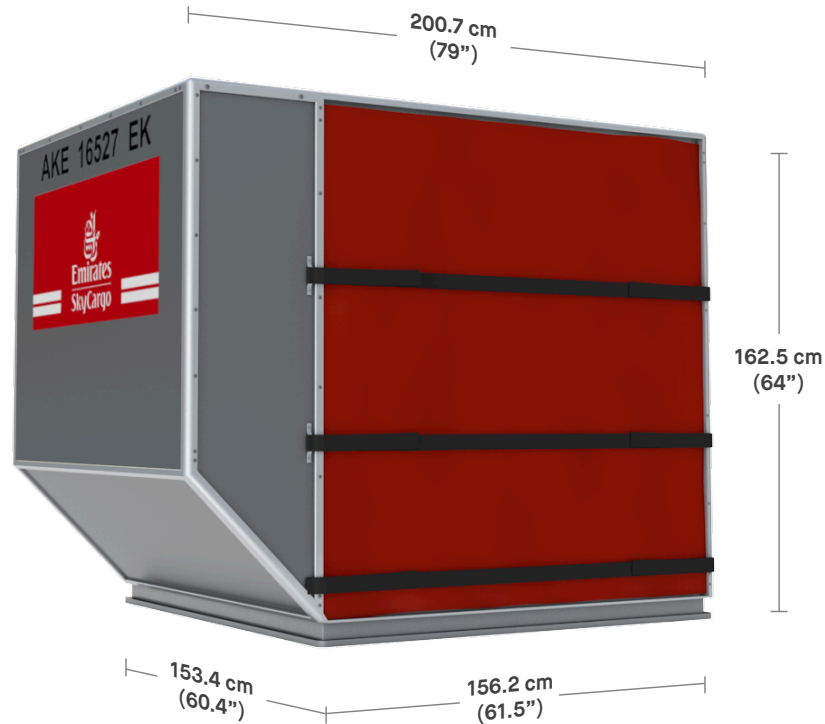

Half-length lower deck container.

## CHARACTERISTICS

Volume .....	4.3m <sup>3</sup>
Standard tare weight .....	70kg
Max. gross weight .....	1,587kg

# LD3 (RKE white container coated with thermal insulators)

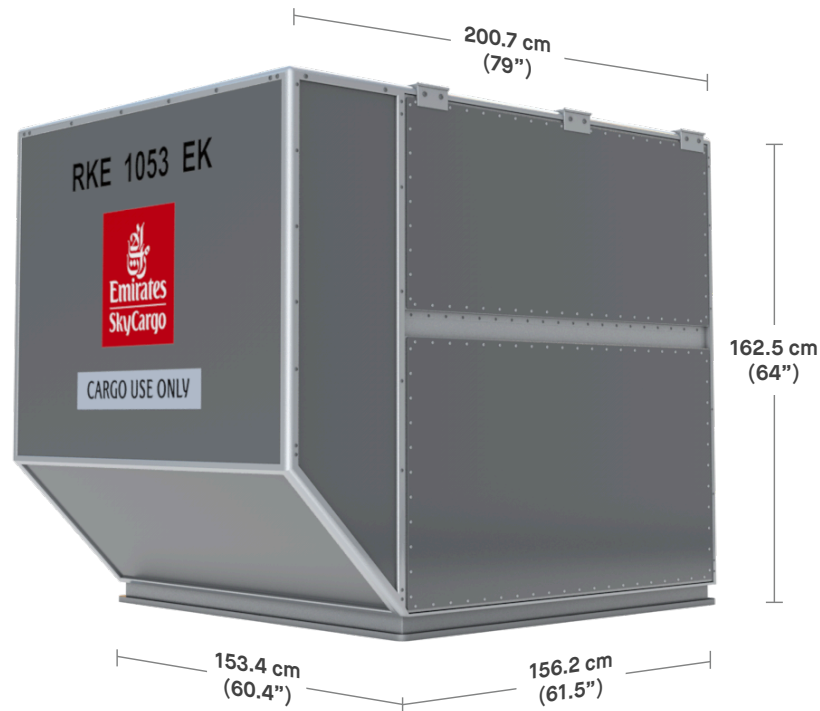

Using coolant trays with thermal insulator coating on the inside.

## CHARACTERISTICS

Volume	3.9m <sup>3</sup>
Standard tare weight	135kg
Max. gross weight	1,587kg
Door	Metal door (lockable and sealable)

# LD6 (ALF contoured container)

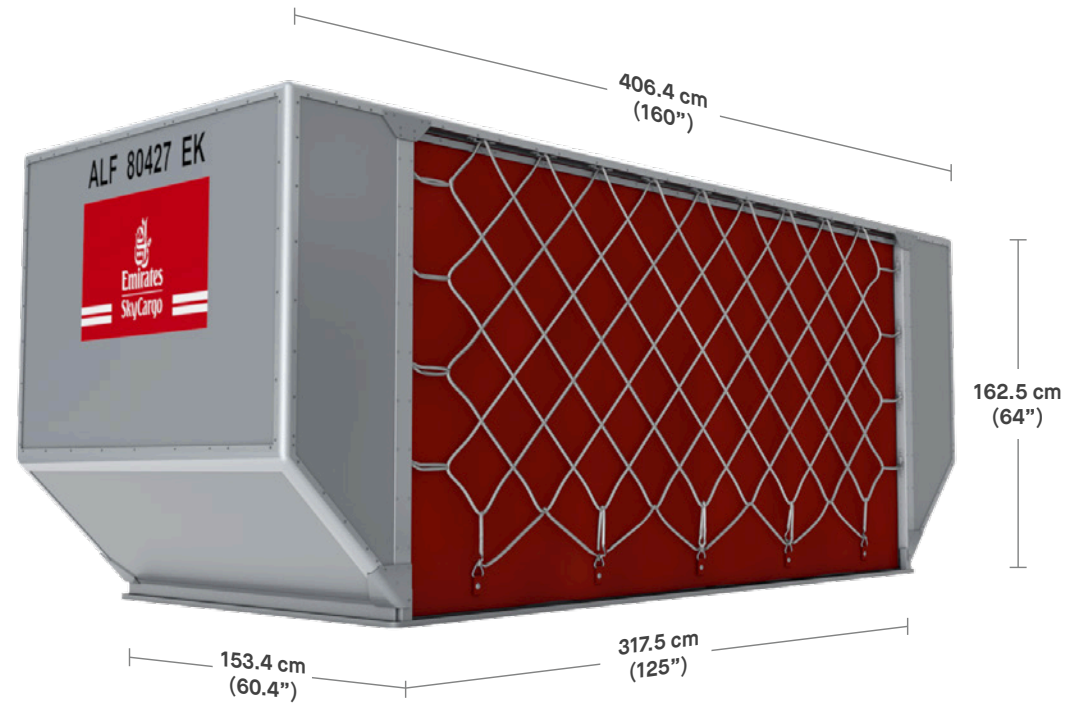

Full-length lower deck container.

## CHARACTERISTICS

Volume	8.7m <sup>3</sup>
Standard tare weight	160kg
Max. gross weight	3,174kg

# LD36 (AMF contoured container)

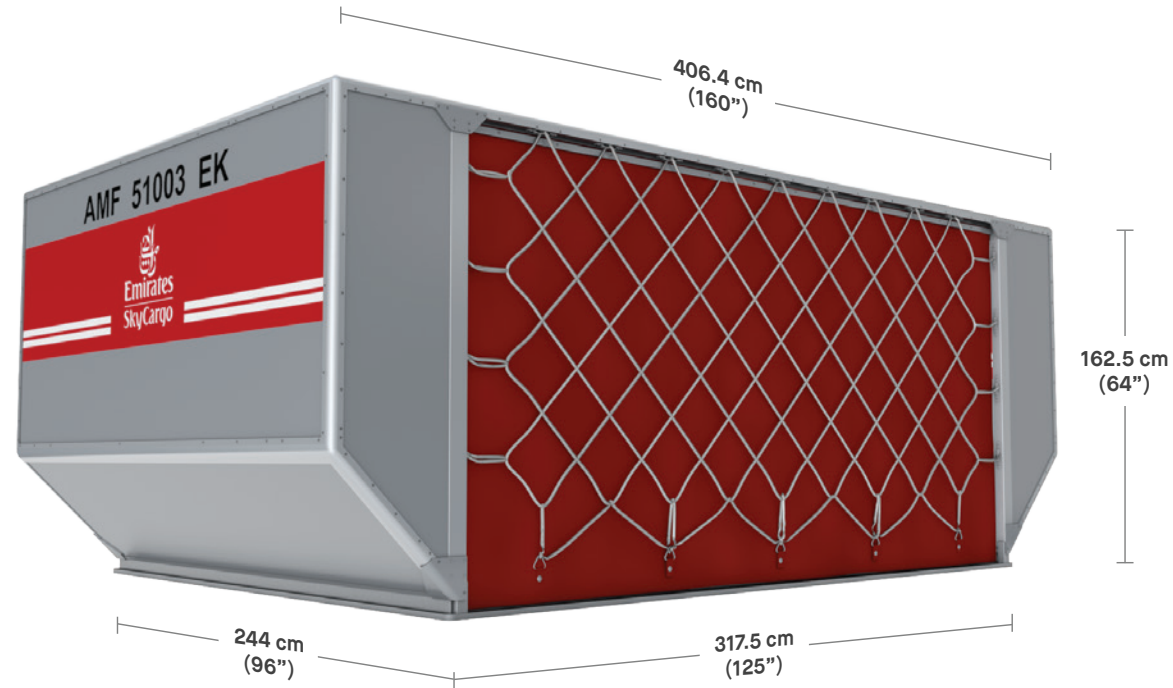

Full-length lower deck container.

## CHARACTERISTICS

Volume	14.5m <sup>3</sup>
Standard tare weight	275kg
Max. gross weight	5,000kg

# PAG passenger & freighter

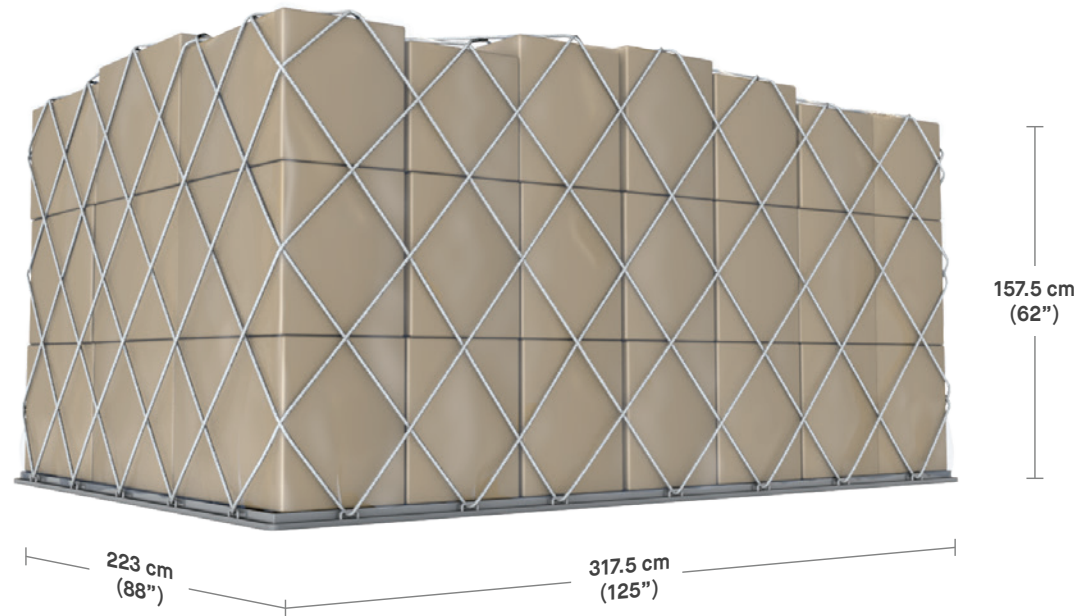

10ft pallet contoured for lower deck.

## CHARACTERISTICS

<b>Volume</b>	10m <sup>3</sup> (at 62" height)
<b>Standard tare weight</b>	110kg (including net)
<b>Max. gross weight</b>	6,804kg (restricted to permitted weight per bay/position on aircraft)

# PGA freighter only



20ft main deck pallet.

## CHARACTERISTICS

<b>Volume</b>	38m <sup>3</sup>
<b>Standard tare weight</b>	550kg
<b>Max. gross weight</b>	13,608kg (can be exceeded with prior approval from Emirates SkyCargo Head Office)



# PKC passenger & freighter

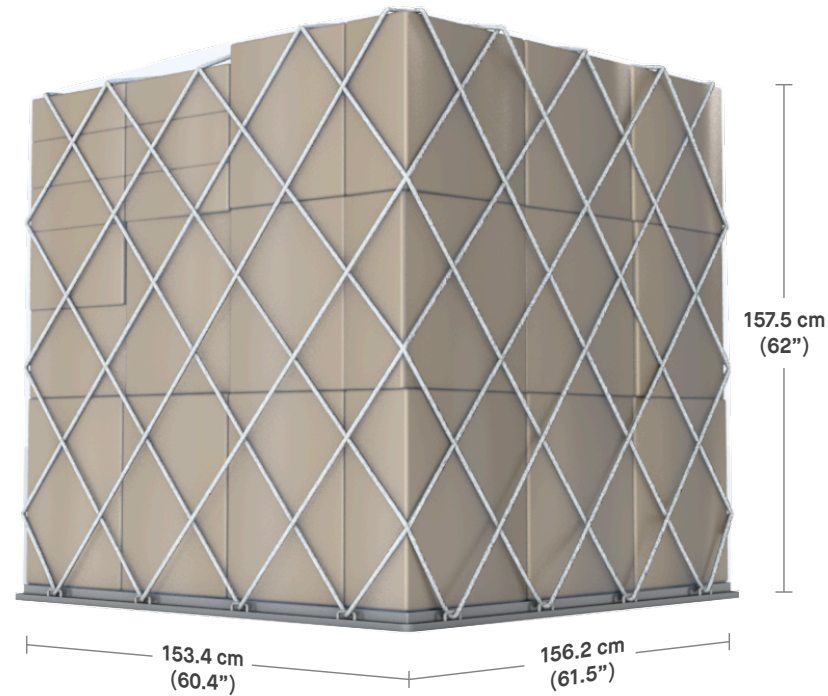

LD3 base pallet for lower deck.

## CHARACTERISTICS

Volume	3.6m <sup>3</sup> (at 62" height)
Standard tare weight	30kg
Max. gross weight	1,587kg

# PLA passenger & freighter

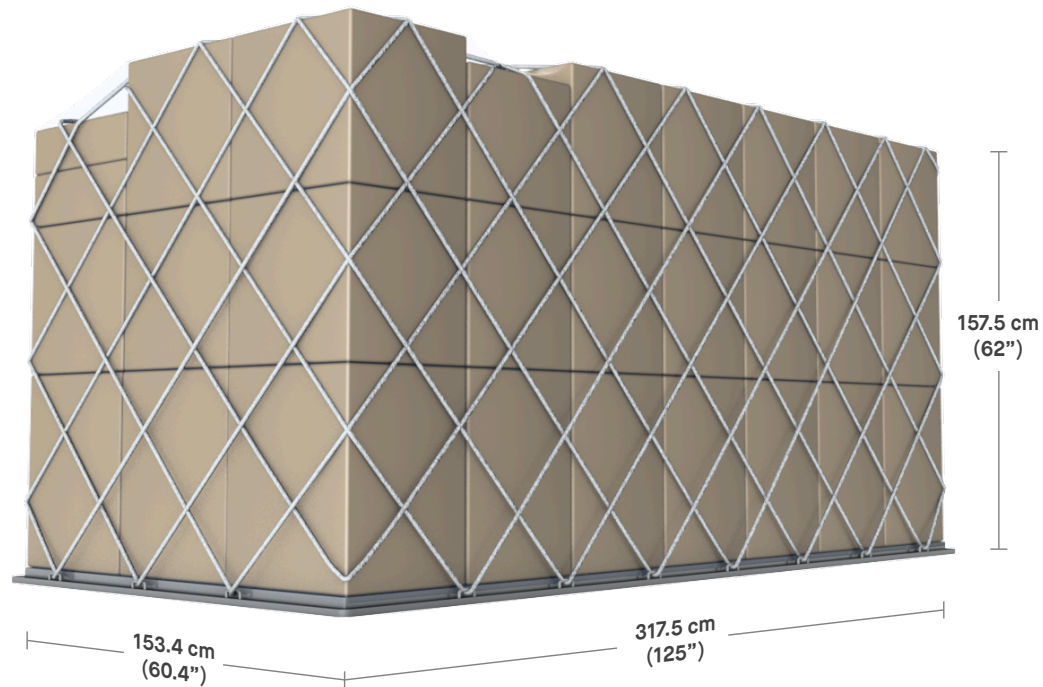

LD6 base pallet contoured for lower deck.

## CHARACTERISTICS

Volume	6.2m <sup>3</sup>
Standard tare weight	100kg (including lashings)
Max. gross weight	3,175kg

# PMC passenger & freighter

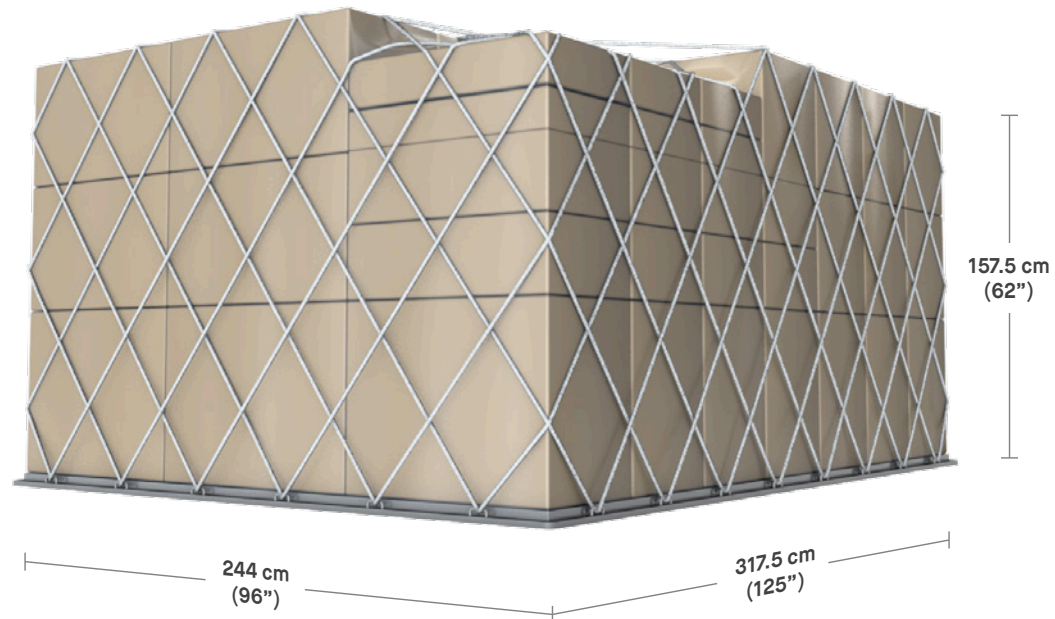

10ft pallet contoured for lower deck.

## CHARACTERISTICS

<b>Volume</b>	10.9m <sup>3</sup>
<b>Standard tare weight</b>	120kg (including lashings)
<b>Max. gross weight</b>	6,804kg (restricted to permitted weight per bay/position on aircraft)

# PMC Q4 freighter only

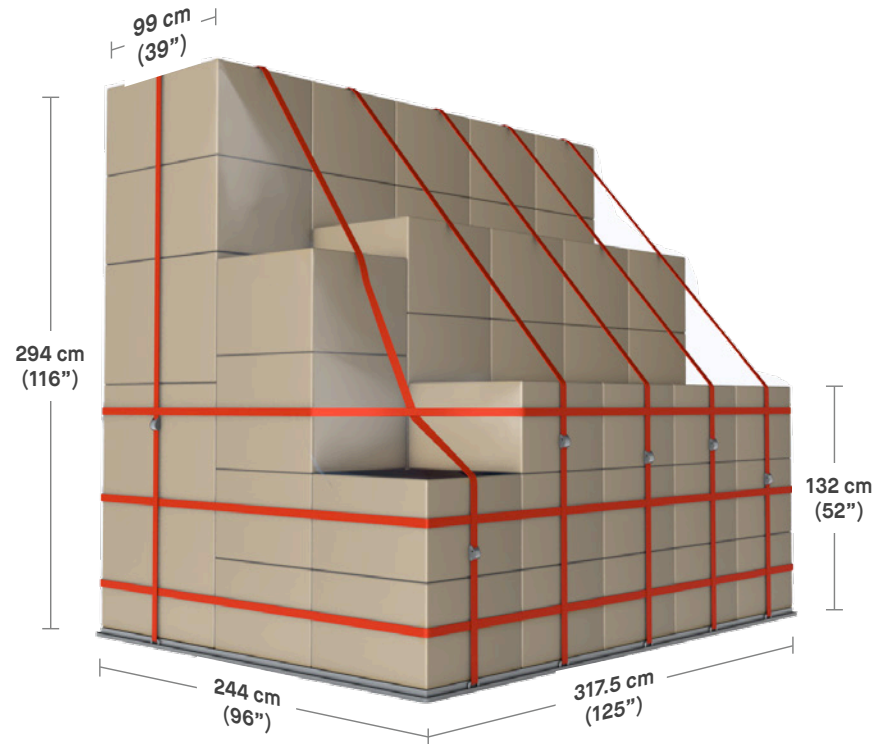

Contoured main deck pallet for Boeing 777F.

## CHARACTERISTICS

Volume .....	17m <sup>3</sup>
Standard tare weight .....	120kg
Max. gross weight .....	6,804kg (subject to aircraft bay/maximum position)

## NOTE:

<b>Contour code:</b> L	<b>Max. height:</b> 294cm
<b>Base:</b> 244cm	<b>Top length:</b> 99cm
<b>Max. height at contour side:</b> 132cm	

# PMC Q5 freighter only

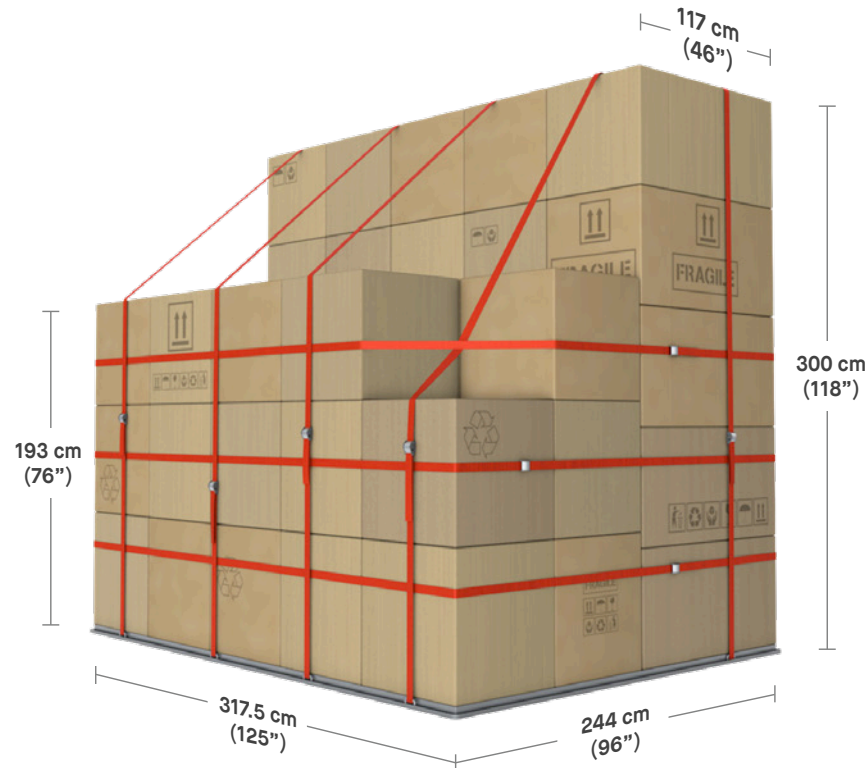

Contoured main deck pallet for Boeing 777F.

## CHARACTERISTICS

Volume .....	19m <sup>3</sup>
Standard tare weight .....	120kg
Max. gross weight .....	6,804kg (subject to aircraft bay/maximum position)

## NOTE:

<b>Contour code:</b> X	<b>Max. height:</b> 300cm
<b>Base:</b> 244cm	<b>Top length:</b> 117cm
<b>Max. height at contour side:</b> 193cm	

# PMC Q6 freighter only

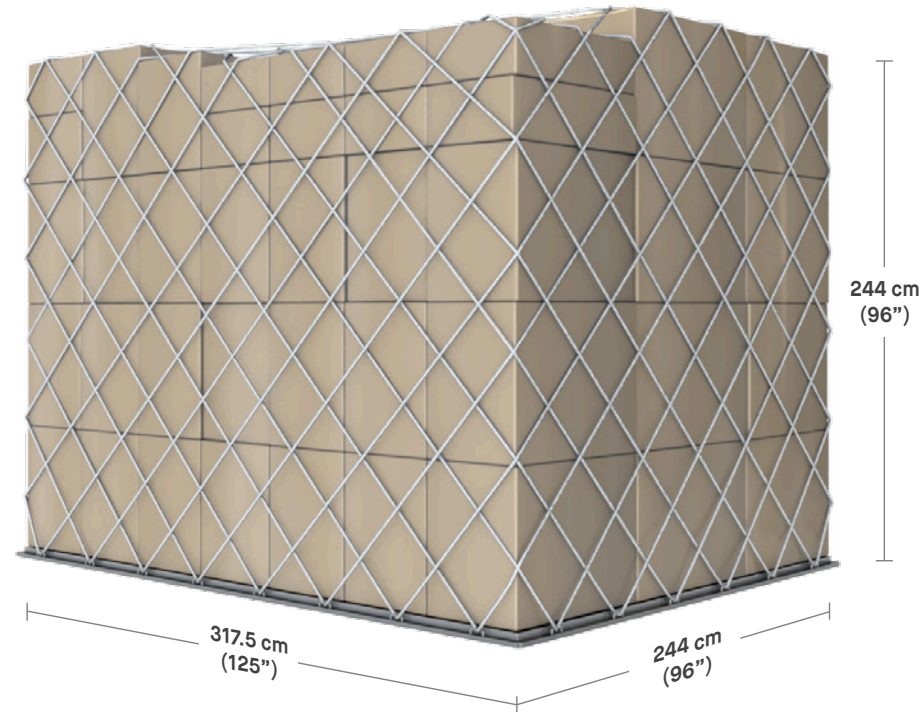

Contoured main deck pallet.

## CHARACTERISTICS

Volume .....	18.9m <sup>3</sup>
Standard tare weight .....	120kg
Max. gross weight .....	6,804kg (subject to aircraft bay/maximum position)

## NOTE:

<b>Contour code:</b> A	<b>Max. height:</b> 244cm
<b>Base:</b> 244cm	<b>Top length:</b> 244cm
<b>Max. height at contour side:</b> 244cm	

# PMC Q7 freighter only

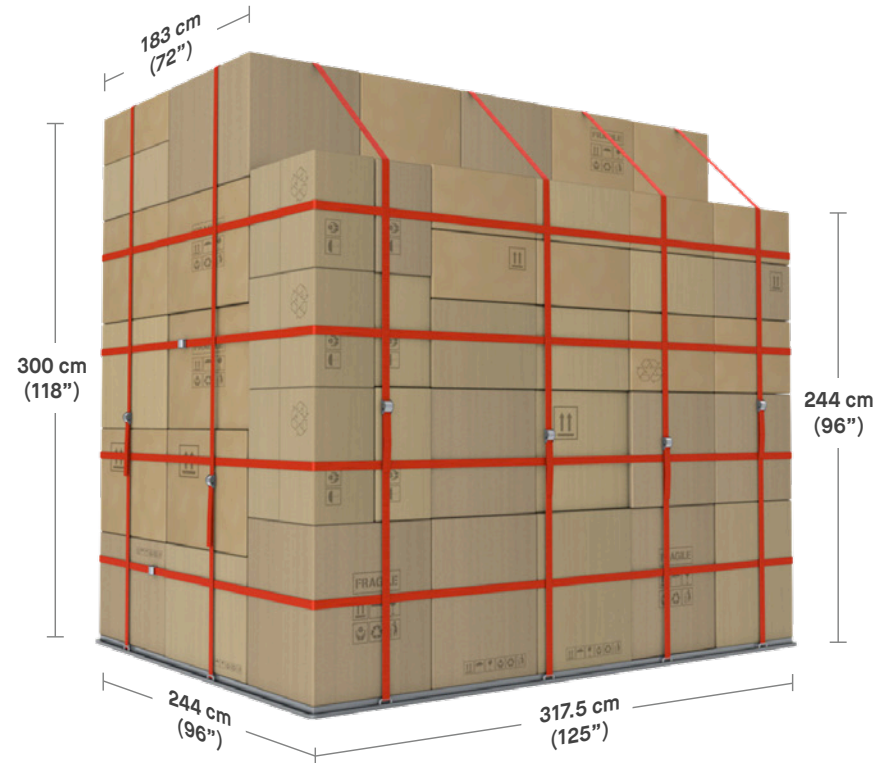

Contoured main deck pallet.

## CHARACTERISTICS

Volume .....	21.5m <sup>3</sup>
Standard tare weight .....	120kg
Max. gross weight .....	6,804kg (subject to aircraft bay/maximum position)

## NOTE:

<b>Contour code:</b> D	<b>Max. height:</b> 300cm
<b>Base:</b> 244cm	<b>Top length:</b> 183cm
<b>Max. height at contour side:</b> 244cm	

# PYB freighter only

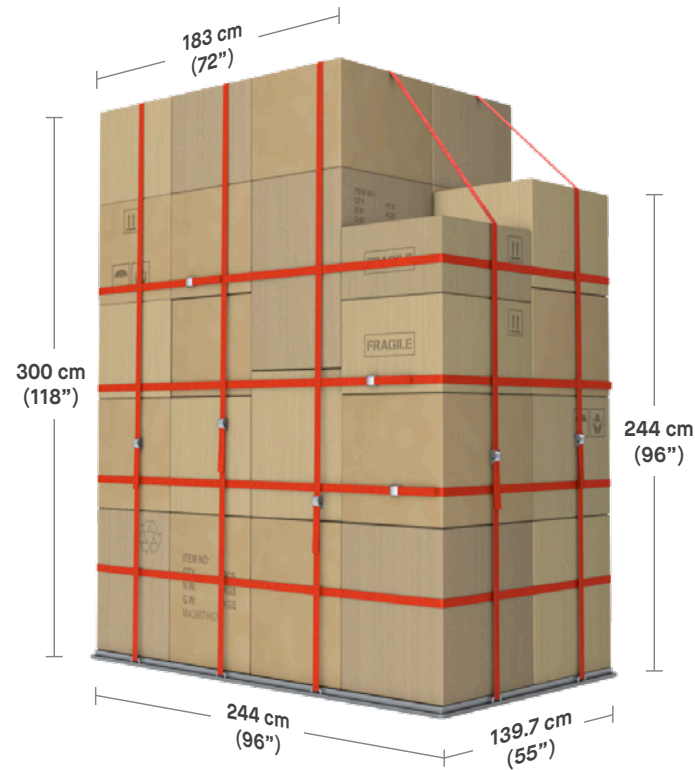

Suitable for loading only at QL and QR position on the main deck of B747F.

## CHARACTERISTICS

Volume .....	7.3m <sup>3</sup>
Standard tare weight .....	60kg
Max. gross weight .....	2,120kg



# PZA freighter only

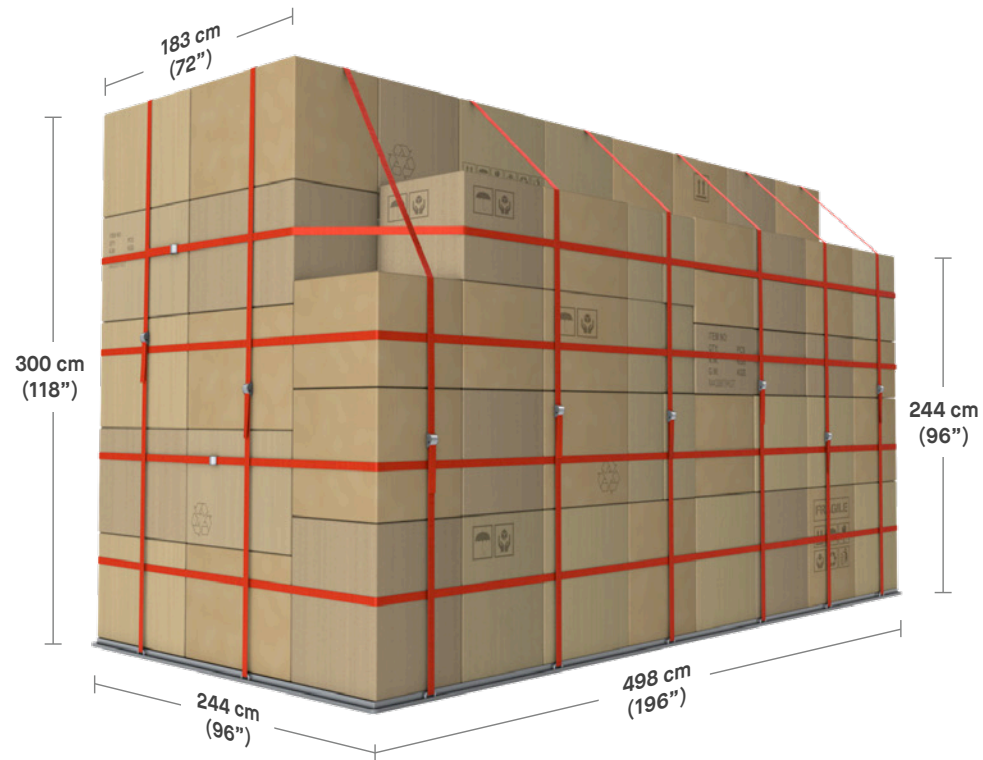

16ft main deck pallet.

## CHARACTERISTICS

Volume	29.6m <sup>3</sup>
Standard tare weight	460kg
Max. gross weight	11,340kg (can be exceeded with prior approval from Emirates SkyCargo Head Office)

# Lower deck cool dolly

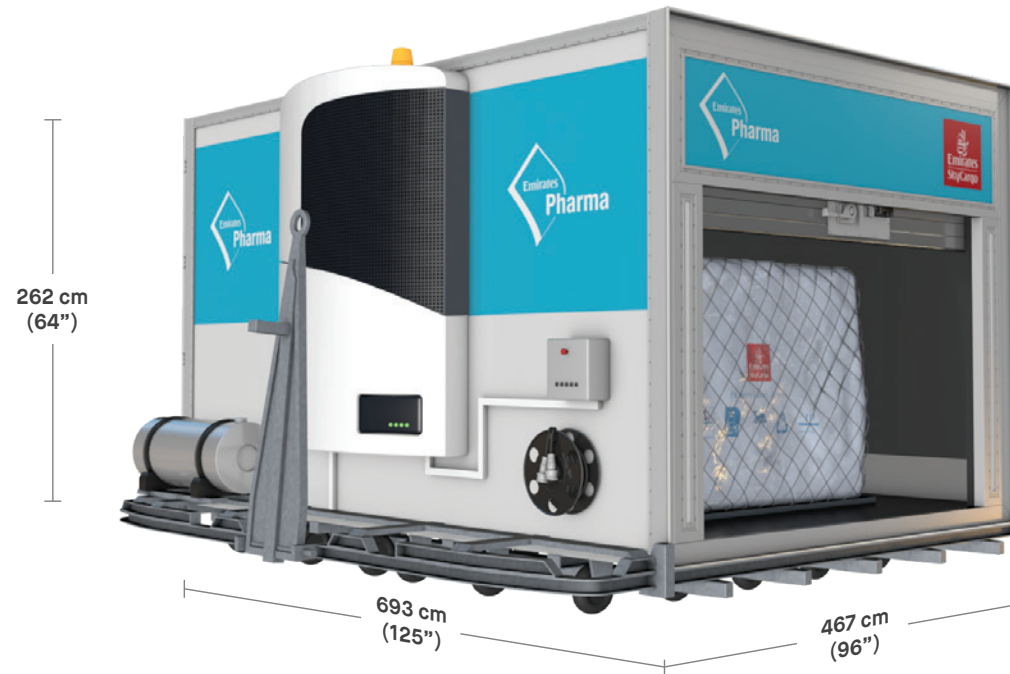

Rectangular mobile storage unit for transportation of temperature-sensitive cargo between storage and aircraft for rapid loading and unloading. These units are also used as an additional storage area, as and when required.

## CHARACTERISTICS

<b>Temperature range</b>	..... -20°C to +20°C
<b>Capacity</b>	..... 1 AMF or ALF or PMC or 2 AKEs
<b>Length</b>	..... 693cm
<b>Height</b>	..... 262cm
<b>Width</b>	..... 467cm

# Main deck cool dolly

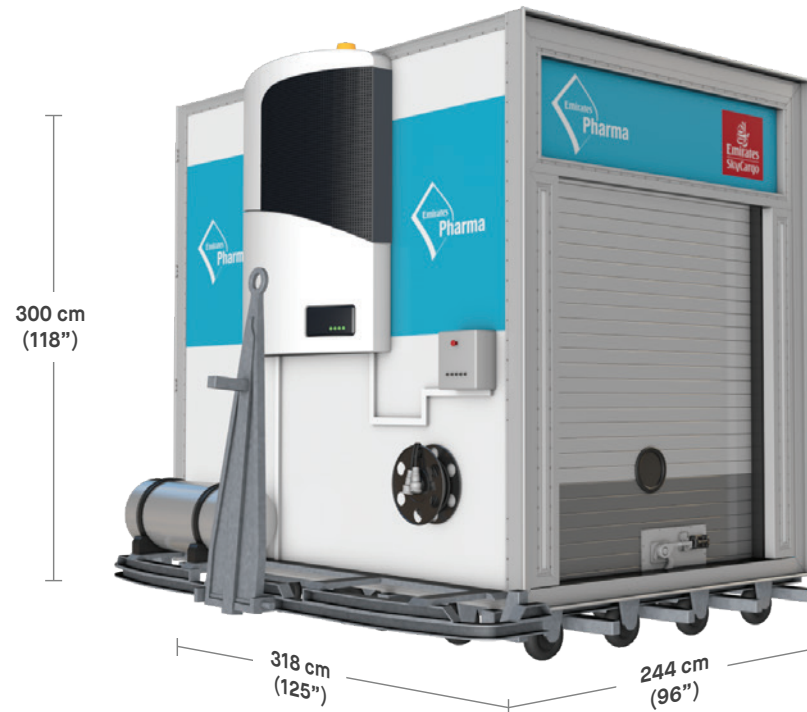

Rectangular mobile storage unit for transportation of temperature-sensitive cargo between storage and aircraft for rapid loading and unloading. These units are also used as an additional storage area, as and when required.

## CHARACTERISTICS

<b>Temperature range</b>	-20°C to +20°C
<b>Capacity</b>	1 AMF or ALF or PMC or 2 AKEs or 1 Q7 contour ULD
<b>Length</b>	318cm
<b>Height</b>	300cm
<b>Width</b>	244cm

# SPN (spider net)

---

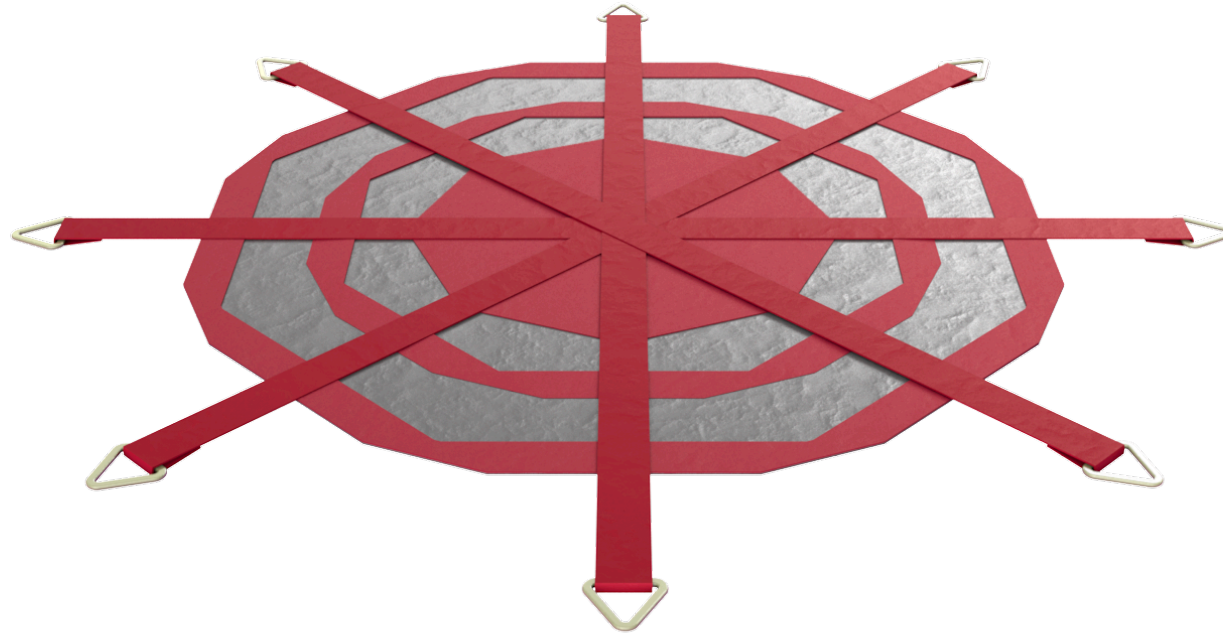

Developed to provide an appropriate means of securely restraining long and thin items like pipes, bars, overhangs, etc. Loads ranging from 50kg up to 1,000kg; able to withstand G Forces of 9G forward and backwards, 3G and 1.5G sideways

## CHARACTERISTICS

---

<b>Tare weight</b> .....	2.5kg
<b>Capacity</b> .....	Rated to 1,515kg limit load and 2,272kg ultimate load
<b>Dimension</b> .....	120cm diameter

# White Cover

---



The White Cover is an innovative cool-chain solution for shielding temperature-sensitive cargo during transit between the storage area and aircraft. Quickly applied in 3 minutes by two Emirates SkyCargo staff, the White Cover is lightweight, water-resistant and shields your products from extreme ambient temperature, hot and cold, yet made of breathable fabric that is 100% environmentally friendly and recyclable. The White Cover is ideal as extra low cost protection for “living” food and even packaged pharmaceuticals.

# LD3 (AKE container with metal door)

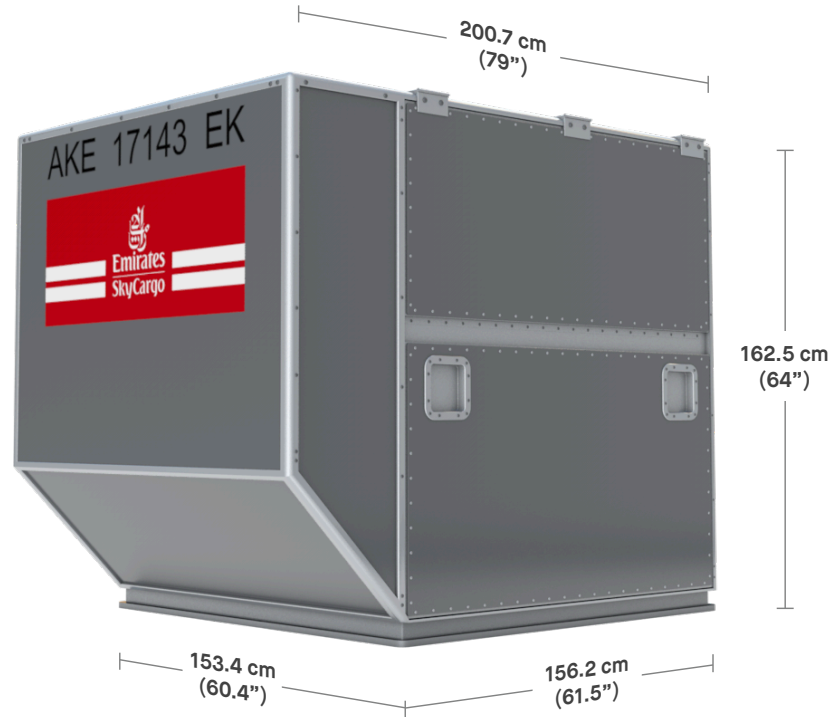

## CHARACTERISTICS

Tare weight	100kg
Maximum gross weight	1,587kg
Loadable volume	4.3m <sup>3</sup>

# XYP (VAL box)

---

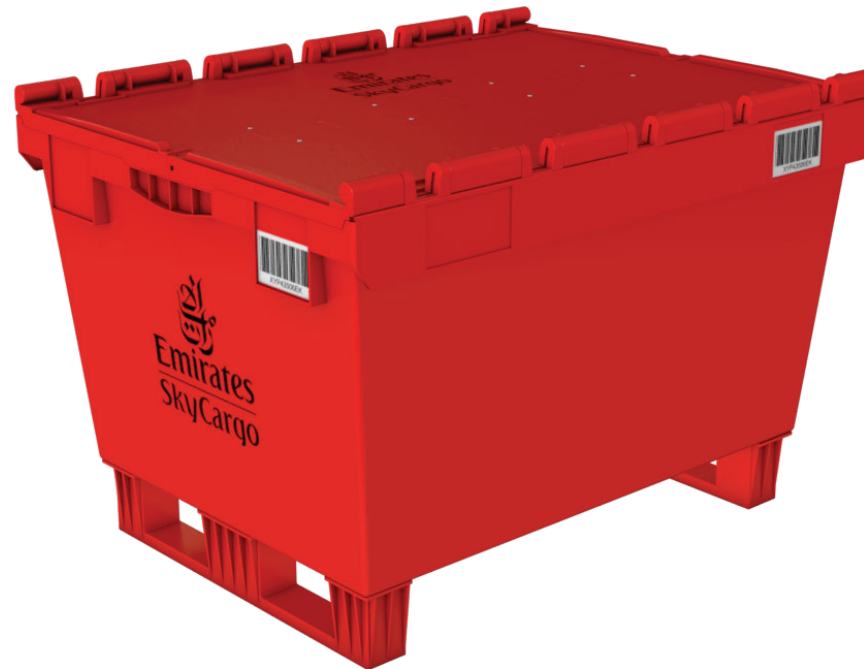

## CHARACTERISTICS

---

Tare weight .....	10.5kg
Maximum gross weight .....	100kg
Internal dimensions .....	71 x 50 x 30cm